

Article number: 20055510

Description: E+G Quick-fit coupling (radial displacement)
GN 240-M8-B

Measures

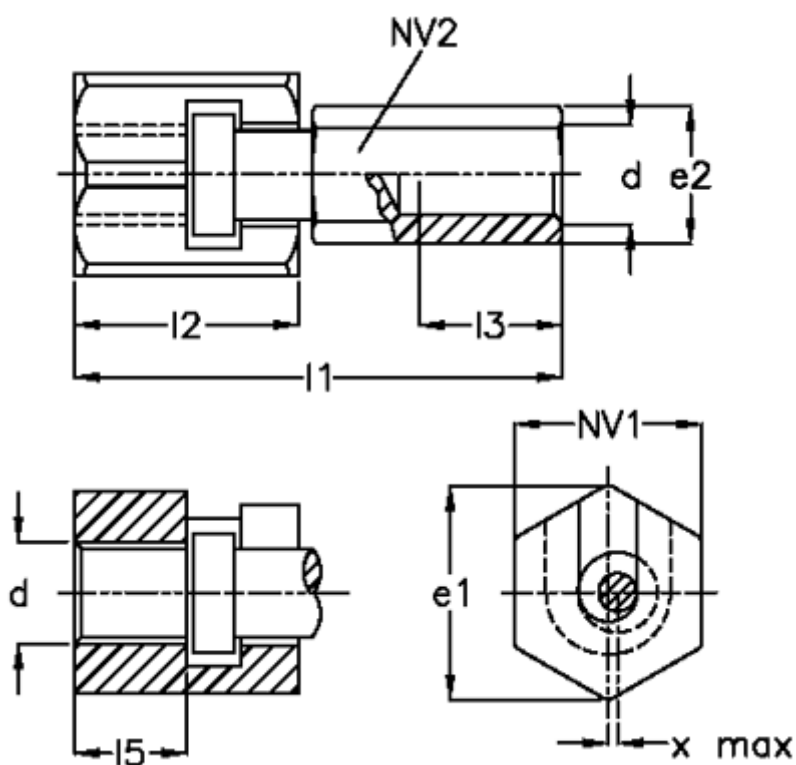

d	= M 8x1,25	Max push-pull strength N = 4500
e1	= 26.0	NV 1 = 24
e2	= 14.5	NV 2 = 13
l1	= 45.0	
l2	= 22.5	
l3	= 13.5	
l5 +1	= 11.5	
Max displacement	= 0.7	